



# THERMALSTEEL

WINDOW CONFIGURATIONS



## ELEVATIONS

Other window configurations available.

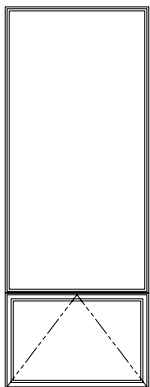

Fixed Over  
Awning

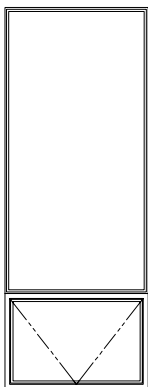

Fixed Over  
Hopper

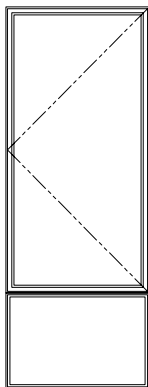

Casement  
Over Fixed

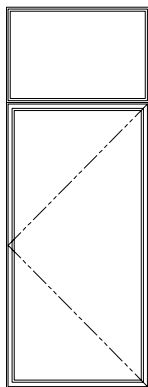

Fixed Over  
Casement

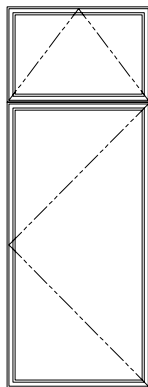

Awning  
Over  
Casement

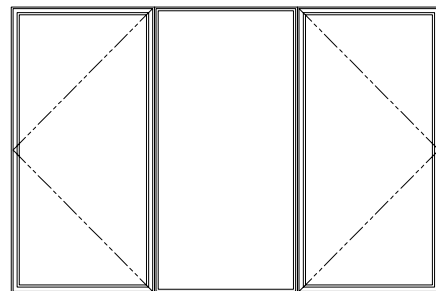

Left, Fixed, Right

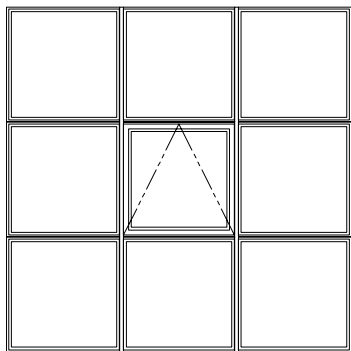

Fixed/Operating  
Window Wall

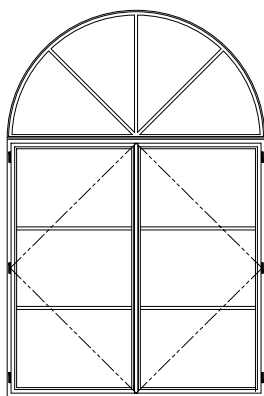

1/2 Round Transom  
Over French Casement

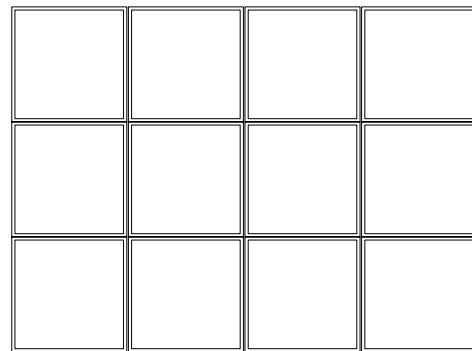

Fixed Window Wall

# THERMALSTEEL

FINISH





**Arcadia Custom's Paint Systems is a multi-step process that combines optimum corrosion protection with the highest weatherability.** Our paint process - combined with a stainless steel substrate - will out-perform all other finishes on mild steel. This durable acrylic polyurethane paint allows for unlimited color choices. Choose from any RAL, Metallic, or Exotic finish. Custom color match paint also available.

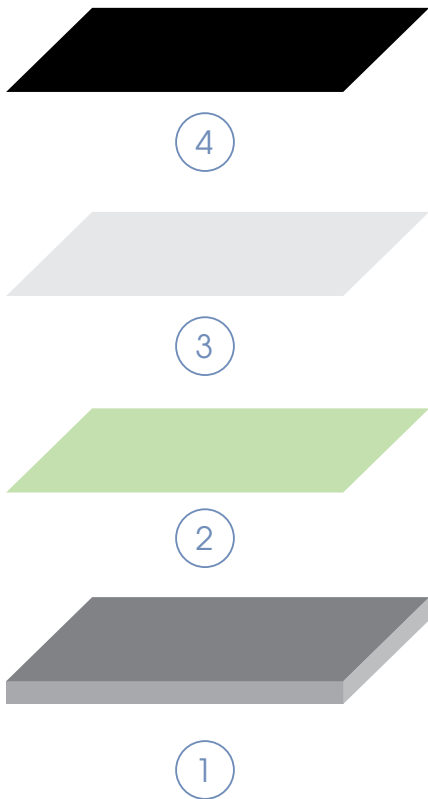

STANDARD PAINT OPTIONS

Textured or smooth paint surface available.



Sift Espresso (Texture)    Jet Black    9011 Black    Atelier Dominique    Argento 305 Metallic



Statuary Bronze    Black Bean Soup    Brick Red    Champagne 301 Metallic    Sandstone

THE PROCESS

- 1: Stainless steel substrate is run through an abrasive blasting treatment producing an anchor bond for primer and paint adhesion
- 2: Acid etch primer coating
- 3: Epoxy primer coating
- 4: High-performance acrylic polyurethane paint coating

**STAINLESS STEEL FINISH:**

- Manufactured from 316 stainless alloy
- #4 brushed stainless surface

**COR-TEN® STEEL FINISH:**

- Manufactured from Cor-ten® steel
- Factory accelerated rust patina

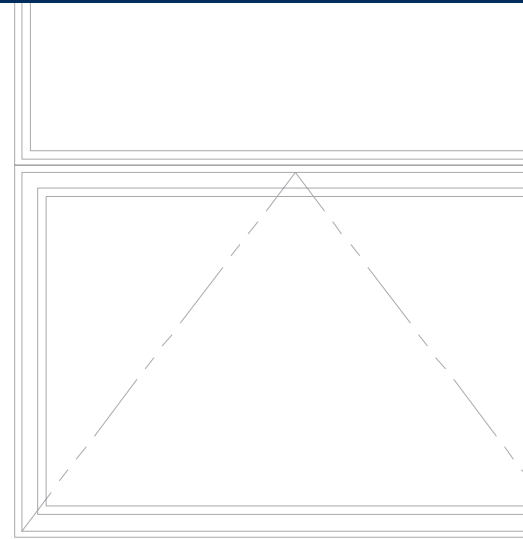

**STAINLESS STEEL FINISH**



Sample Texture

**COR-TEN® STEEL FINISH**



Sample Texture

Living finish will continue to change in appearance, rust staining possible

# THERMALSTEEL

WINDOW HARDWARE





**FEATURES:**

- Solid bronze hinges
- Solid bronze hardware trim available
- Stainless steel roto-crank arms for corrosion protection
- Several finish options available

**WINDOW HINGE TYPE**



Butt Hinge - Standard  
(Solid Bronze)

\*See finish options below.



Acorn Hinge - Optional  
(Solid Bronze)

\*See finish options below.



Concealed Friction Hinge  
(Stainless Steel)

Available on Push-Out, Awning, and Hopper.  
Weight limit 120lbs.

**\* BRONZE HARDWARE FINISH OPTIONS**



White Light



Medium Pewter



Silicon Light



Silicon Medium



Silicon Dark



Blackened  
Bronze



Dark Pewter  
Antique



**Simplex - Single Point**

Available on push-out, in-swing.  
Two locks on windows over 48".  
\*See finish options previous page.



Black  
(Standard)

Brushed  
Nickel

**Multi-point Trim (Steel)**

Black and nickel finish only.



Black  
(Standard)

Brushed  
Nickel

**Crank-Out Operator (Steel)**

Out-swing window only.  
Black and nickel finish only.



**Bronze Multi-point Sash T-Pull**

Used with multi-point trim on  
push-out window.  
\*See finish options previous page.



**Bronze Multi-point Trim**

\*See finish options previous page.



**Bronze Crank-Out Operator**

Out-swing casement window only,  
(not available for awning windows).  
\*See finish options previous page.

# THERMALSTEEL

WINDOW SYSTEMS

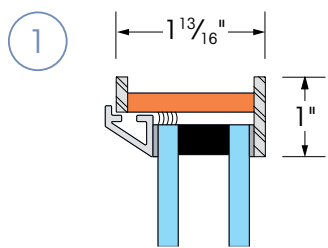

Exterior

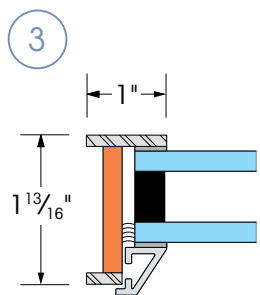
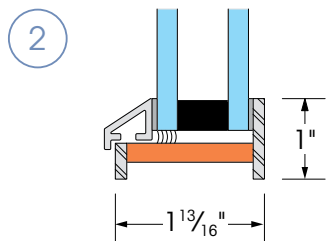

Exterior

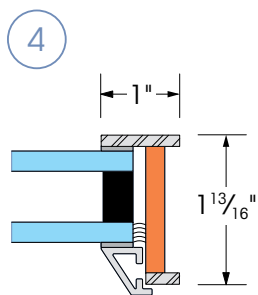

ELEVATION

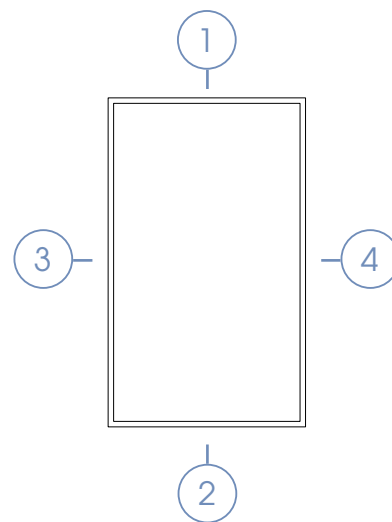

SILL ANCHORING OPTIONS

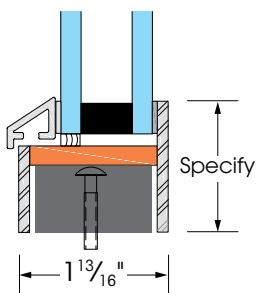

Composite Sill Block

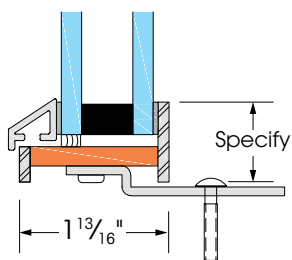

Anchor Clip

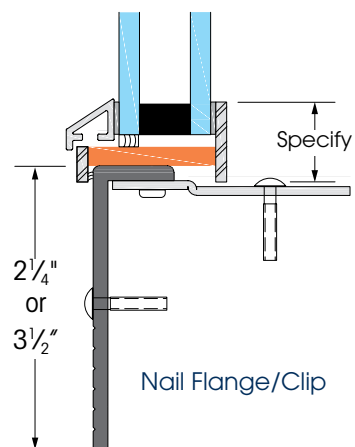

Nail Flange/Clip